

VETEK



Personvåg kroppsanalys WBA 300
OBS! Endast avändardelarna i denna manual är på Svenska.

USER MANUAL



Read this manual carefully before using the instrument

INDEX

2.	GENERAL RULES.....	PAG. 2
3.	SAFETY.....	PAG. 3
4.	TECHNICAL SPECIFICATION.....	PAG. 4
5.	INDICATOR.....	PAG. 5
6.	INSTALLATION.....	PAG. 7
7.	GENERAL CONDITIONS FOR CORRECT MEASUREMENT.....	PAG. 8
8.	INSTRUCTION FOR USE.....	PAG. 8
9.	PRINT FUNCTION.....	PAG. 12
10.	MAINTENANCE AND ASSISTANCE.....	PAG. 13
11.	COMFORMITY.....	PAG. 13
12.	SCRAPPING AND WASTE DISPOSAL.....	PAG. 13
13.	WARRANTY.....	PAG. 14
14.	THERMAL PRINTER.....	PAG. 15
15.	ASSEMBLY-USE MECHANICAL TELESCOPIC HEIGHT METER (OPTIONAL).....	PAG. 18

By choosing the **WUNDER** mod. **WBA** professional electronic scale, you have purchased a high precision instrument.

Since over 40 years **WUNDER** has placed its experience at the service of health. This instrument is calibrated in conformity with accuracy class III.

The instrument is characterized by the possibility of fixing the electronic terminal to the weighing platform by means of a column or else installing the terminal autonomously.

The instrument is equipped with a dual LCD electronic terminal with triple reading to simultaneously view Weight, Height. and BMI

2. GENERAL RULES

 **Carefully read this manual before using the instrument as it supplies important indications concerning OPERATING SAFETY AND MAINTENANCE.**

The descriptions and illustrations supplied in this manual are not binding.

WUNDER reserves the right to modify its products as deemed convenient in order to approve them without being committed to update this publication.

Conventions:

The following symbols have been used in this manual:



0470 MEDICAL CERTIFICATION



METROLOGICAL CERTIFICATION AND APPROVAL FOR MEDICAL USE



ACCURACY CLASS



ASSISTANCE WARRANTY CERTIFICATE



ATTENTION!

PLACED BEFORE DETERMINING PROCEDURES. COMPLIANCE FAILURE CAN DAMAGE THE PRODUCT



WARNING!

PLACED BEFORE DETERMINING PROCEDURES. COMPLIANCE FAILURE CAN HARM THE OPERATOR OR PATIENT OR DAMAGE THE PRODUCT



WASTE DISPOSAL



TYPE B PARTS SUPPLIED



BATTERY POWER



INDICATION OF WEIGHT FUNCTIONALITY

INDICATION OF STABLE WEIGHT



INTERFERENCE COULD OCCUR NEAR THE APPLIANCES



DUAL INSULATION

3. SAFETY



WARNINGS!

Operators must read this manual carefully, comply with the instructions it contains and become familiar with the correct use and maintenance procedures of the instrument.

- Retain this manual for consultation and as a help in staff training

- Do not overload the instrument beyond its maximum capacity
- Do not apply loads abruptly.
- Do not press the keys with sharp or pointed objects
- Do not try to open the instrument.
- Do not remove seals from the instrument.
- Do not short-circuit the battery terminals
- Use only the power supply provided by Wunder. Before using it, make sure that the local mains voltage is compatible with the voltage of the adapter shown on the identification plate
- Regularly check the integrity of the instrument's power cord and make sure it does not come in contact with hot appliances
- Make sure that the power cord does not create obstruction hazards
- Unplug the instrument before cleaning it
- Do not place the instrument in water or other liquids
- Perform maintenance and subsequent metric verifications regularly



WARNING : People with pacemakers and other medical devices internal.

Note that people with an electronic medical implant, such as a pacemaker, should not use WBA, as it passes a low-level electrical signal through the body, which may interfere with its operation.



WARNING!

For the use of the instrument by persons with disabilities, it is recommended to include qualified assistance.
Keep the instrument out of the reach of children.



WARNING:

The body composition analyzer, should be used with bare feet. Be sure to clean the weighing platform with appropriate disinfectant after each use.
Do not pour any liquid directly on the weighing platform, to avoid damaging it.
To clean the platform, use a soft cloth moistened with ethyl alcohol.
Avoid the use of harsh chemicals, excessive amounts of water or high pressure washing systems.
When cleaning, always remove the power cable, avoid touching it with wet hands.

4. THE TECHNICAL SPECIFICATION

Model	WBA
Capacity	300g
Division	100g
Unit weight	kg
OIML	Class III
Display	1" LCD weight 5 digits 20mm ; 2" LCD BMI/ % Fat Mass
Function Keys	ON-OFF, Zero, Tare, Printer; Body type; Sex, Time, Numerical keys 0~9; Reset key ; Enter key
Technology BIA	Bioelectrical Impedance Analysis 4 feet- electrode
Impedance frequency	50kHz 500uA

Impedance Range	200 ~ 1000Ω / 0.1Ω	
Age Range	10 ~ 80 years, increase of 1 year	
Height Range	60 ~ 210cm / 3ft ~ 7ft 11.0in	
Power	Rechargeable Batteries 7.2V 2000mA o batteries AA (1.5X6) 9V.Medical Adapter AC 12V 2A	
Platform dimension	340 (L) x 450 (P) x 80 (H) mm	
Temperature Use	5°C ~ 35°C - 30% / 80% UR	
Storage temperature	-20°C ~ 60°C - 0% / 90 % UR	
Output	RS232 9 pin female	
Optional (not included)	External thermal printer; Telescopic height meter	
Printer Data	Date	GG/MM/AAAA hh:mmEs: 30/10/2013 10:55
	Mode	Standard / Athletic
	Sex	Male / Female
	Age	10 ~ 80 years, increase of 1 year
	Height	60 ~ 210cm / 3ft ~ 7ft 11.0in
	Weight	0 ~ 300 kg
	BMI	Increase of 0.1
	BMR	Increase of 1 kcal
	Fat %	5 ~ 50% / increase of 0.1%
	Fat kg	Increase of 0.1 kg
	FFM	Increase of 0.1 kg
TBW	Increase of 0.1 kg	

5. INDIKATORN

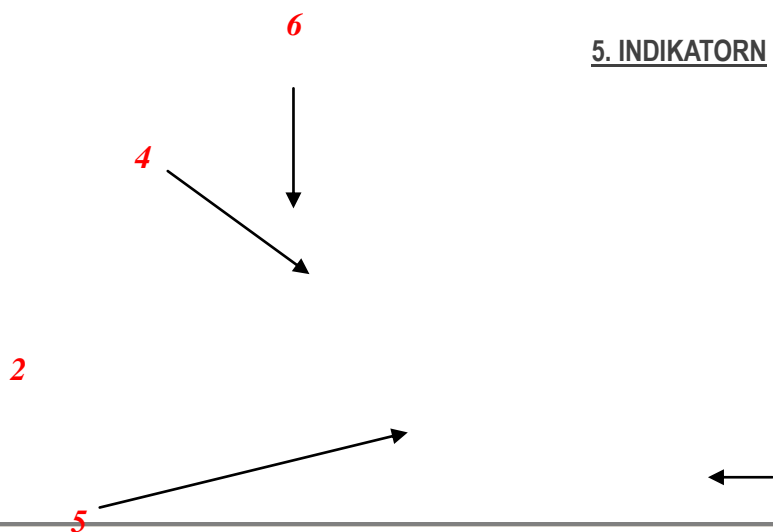

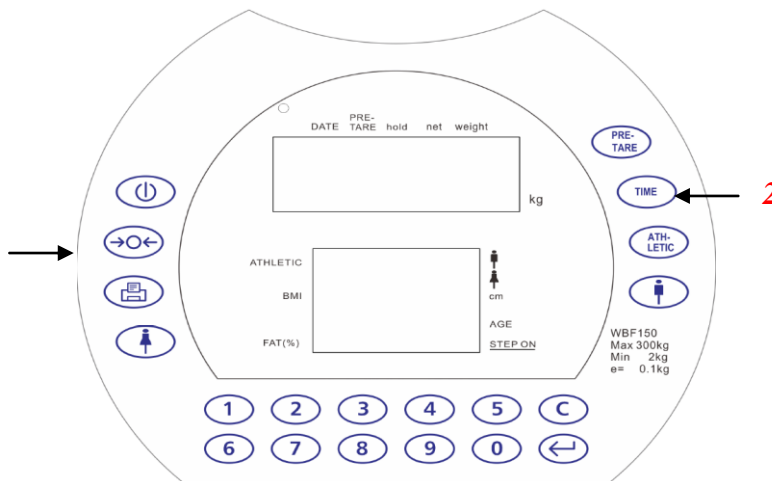

2. Huvudfunktion (8 knappar)
3. Numeriskt tangentbord
4. Uppmätt vikt
5. Uppmätt BMI och kroppsfett(%)
6. Strömförsörjning

Tangentbord

Knapp	Förklaring
	AV/PÅ-knapp, håll in i 3 sekunder för att stänga av vågen
	Den har nollställt sig (upp till ±2% av maximal kapaciteten)
	Skrivare
	Kvinna
	Man
	ATHLETIC MODE: En person som tränar mer än 12 timmar per vecka och har en vilopuls på under 60 slag per minut. Personer som har sportat i flera år men för tillfället tränar mindre än 12 timmar per vecka. Nybörjare som tränar mer än 12 timmar per vecka men som inte har en atletisk kroppsform räknas inte hit.
	Datuminställning
	Tare-funktion för att ta bort vikt som inte ska räknas med, t ex kläder.
	Data Cancel
	ENTER
	Numeriskt tangentbord

Skärmfunktioner:

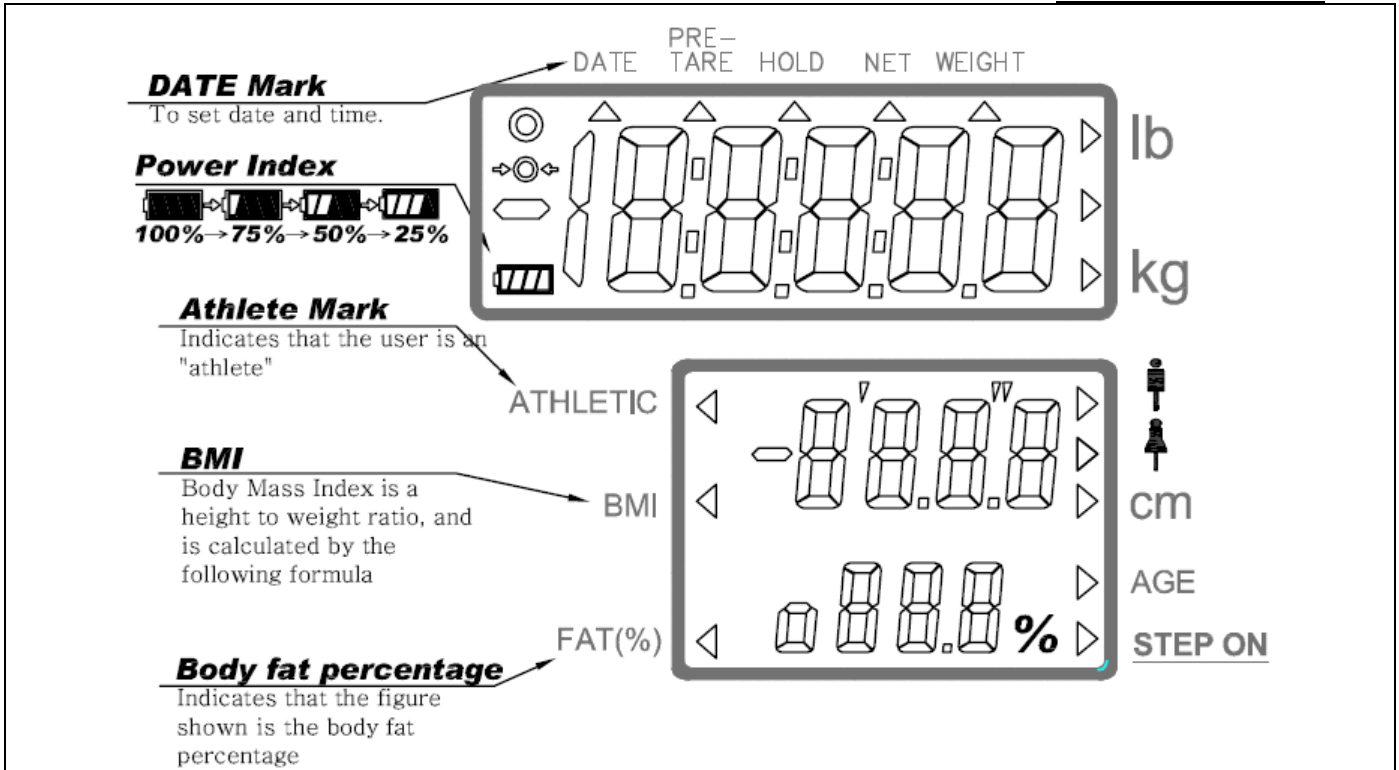

DATE Mark
To set date and time.

Power Index
100% → 75% → 50% → 25%

Athlete Mark
Indicates that the user is an "athlete"

BMI
Body Mass Index is a height to weight ratio, and is calculated by the following formula

Body fat percentage
Indicates that the figure shown is the body fat percentage

DATE PRE-TARE HOLD NET WEIGHT

lb

kg

ATHLETIC

BMI

FAT(%)

cm

AGE

STEP ON

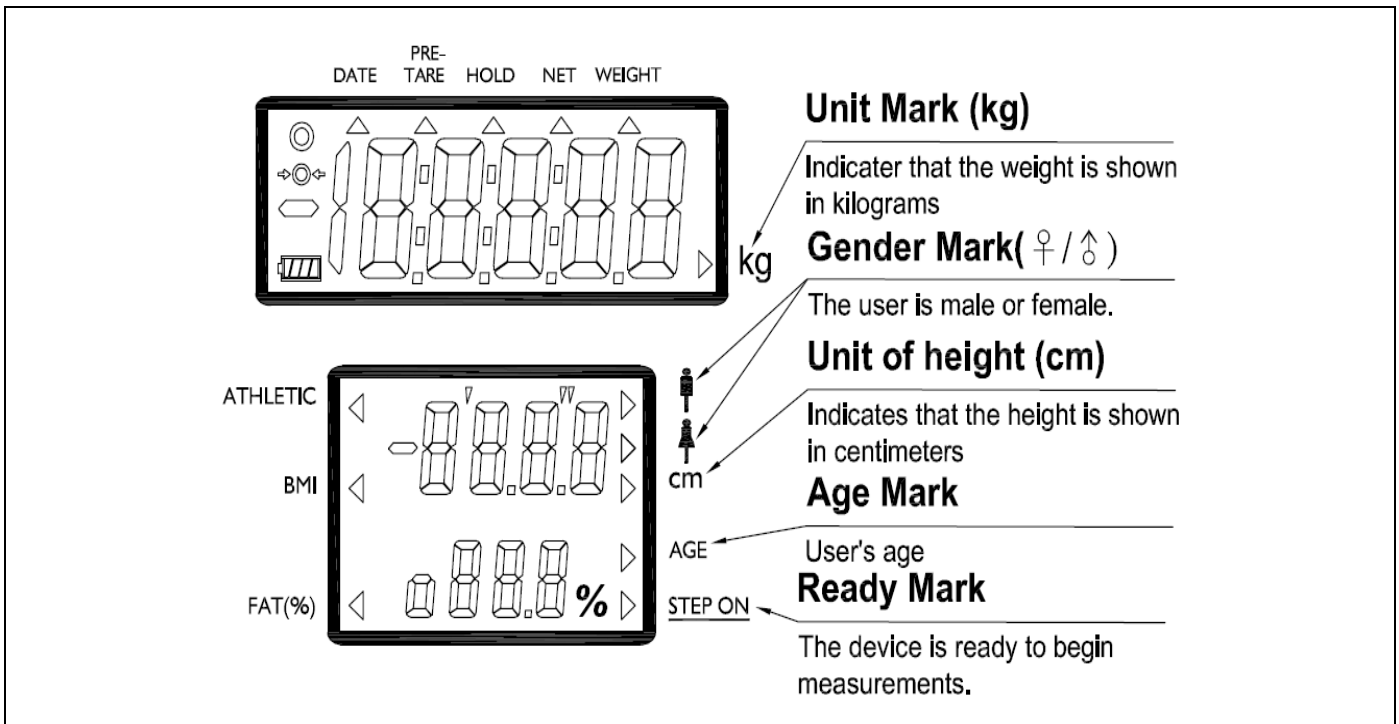

DATE PRE-TARE HOLD NET WEIGHT

Unit Mark (kg)
Indicator that the weight is shown in kilograms

Gender Mark (♀ / ♂)
The user is male or female.

Unit of height (cm)
Indicates that the height is shown in centimeters

Age Mark
User's age

Ready Mark
The device is ready to begin measurements.

ATHLETIC

BMI

FAT(%)

kg

cm

AGE

STEP ON

6. INSTALLATION





AFTER HAVING VERIFIED THE INTEGRITY OF THE EQUIPMENT AND OF ALL ITS COMPONENTS, CONNECT THE INSTRUMENT WITH THE SUPPLIED POWER SUPPLY TO CORRECTLY RECHARGE THE BATTERIES

Position the instrument on a level and stable surface

The instrument must be placed away from heat sources, in an environment without excessive vibrations and drafts.

<p>Verification of equipment:</p> <p>Model WBA 300 with printer</p> <ol style="list-style-type: none"> 1. Base scale with support for column 2. Column and display 3. Thermal printer mounted on the column with a metal support with of the printer: already mounted on the column 4. External power supply for the scale 5. External power supply for the printer 6. User manual 7. Height meter (optional not included)

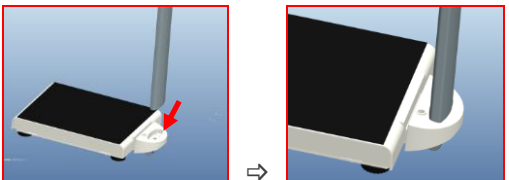
Assembly (for column version only)

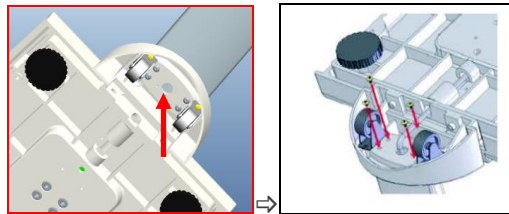
<p>Figure A</p> 	<p>Assembly is easy: fix scale's column to the weighing platform (See Figure A)</p> <p> ATTENTION!</p> <p>FOLLOW THE INDICATIONS BELOW BEFORE INSERTING THE COLUMN</p>
<p>Figure B Figure C</p> 	<ul style="list-style-type: none"> • Overturn the weighing platform resting it onto a level surface. • Remove the display connector from inside the column and connect it to the weighing platform connector, making it pass through the hole indicated by the red arrow (see Figure B). • Fix the column to the weighing platform support using the 4 supplied screws. (see Figure C). • Position the instrument on the floor and adjust the 5 feet to it. • To use, connect the supplied external power supply to the current (see battery operation)

7. GENERAL CONDITIONS FOR CORRECT MEASUREMENT



Preventive steps to be carried out in advance of the test execution

1. To ensure accuracy, readings should be taken away from the meals. This is necessary since the mass of the food is measured together with the weight and it is susceptible to precise measurement.
2. Prior to testing, if possible, you should urinate and defecate. Although not included in the elements that constitute the body mass, the volume of urine and excrement is included in the measurement.
-
3. Did not run in conjunction with the following medical devices:
 - Pacemakers and electro medical equipment like (Bypass).
 - Systems of artificial life, such as artificial hearts or lungs
 - Portable electrical devices, such as electro-cardiographs
4. Trying to be at rest before performing the test: strenuous exercise or sudden movements can cause temporary changes in body composition.
5. Whenever possible, avoid performing the test after taking a shower or a sauna
The exudation causes temporary changes in body composition.
6. Did not take the test during the menstrual cycle
Women experience an increase in water in the body during the menstrual cycle
7. Perform the test at normal temperatures (20 ° C-25 ° C)
While the human body is stable at normal temperatures, body composition is susceptible to extreme heat or cold.
8. Always remember that more the body condition of the various measurements are similar and standards (eg wearing the same clothing, running the test before eating and do any type of exercise, etc. ..), plus the test results are reproducible and reliable.

8. INSTRUKTION FÖR ANVÄNDNING

8.1 Instruktion för laddning och anslutning

Om  lyser på skärmen är batterinivån låg, anslut adaptern till vågen.

Adaptern kopplas in på baksidan av skärmen.

Batteriet bör laddas minst var tredje månad oavsett om vågen används eller inte. Har vågen stått en lång period, längre än tre månader, bör batteriet användas en hel cykel (laddning/urladdning) för att återfå sin fulla kapacitet.



**Inkoppling av adapter
för nätspänning**

8.1a Byte av batterier

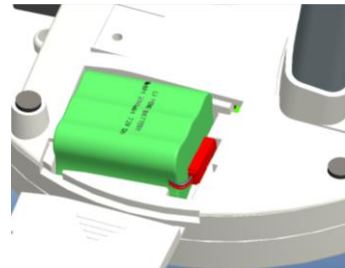
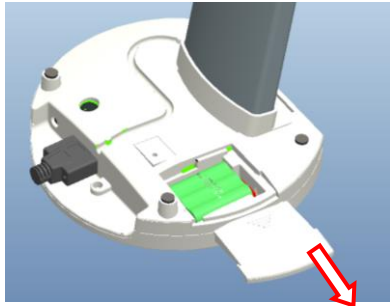



1. Öppna batteriluckan och ta ut batteriet.
2. Koppla ur det uppladdningsbara batteriet och byt ut det mot ett nytt. Lägg tillbaka batteriet och ordna kablarna så luckan går att stänga igen.

8.2 INSTÄLLNING AV DATUM OCH TID

Håll in knappen TIME i 3 sekunder för att kunna ändra tiden.

Exempel: att programmera tiden till 25 December 2008, 8:00 a.m.

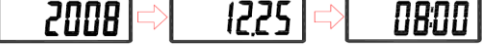
	<p>Programmering av årtal: använd nummerpanelen för att skriva in årtalet, tryck sedan in TIME för att komma vidare till nästa steg.</p>
	<p>Programmering av datum: använd nummerpanelen för att skriva in månad:dag, tryck sedan in TIME för att komma vidare till nästa steg.</p>
	<p>Programmering av tid: använd nummerpanelen för att skriva in tiden, tryck sedan in TIME för att komma vidare till nästa steg.</p>
	<p>Tidsformatet: ÅÅÅÅ → MM.DD → HH:MM</p>

8.3. VANLIG VÄGNING:

1. Tryck på av/på-knappen 
2. Placera personen som ska vägas på vågen och skärmen kommer visa vikten.

8.4 WEIGHT & BODY COMPOSITION



**INFORMATIONEN SOM VÅGEN GER SOM ANVÄNDS FÖR ATT BESTÄMMA KOST/DIETER
OCH TRÄNINGSPROGRAM MÅSTE TOLKAS AV KVALIFICERAD PERSONAL**

<p>1</p> <p>Tryck på knappen den översta skärmen kommer visa 0.0kg</p>	<p>2</p> <p>Välj kroppssammansättning med eller, eller och tryck på för att bekräfta</p>
<p>3</p> <p>Skriv in längden och tryck på </p>	<p>4</p> <p>Skriv in ålder och tryck </p>

5

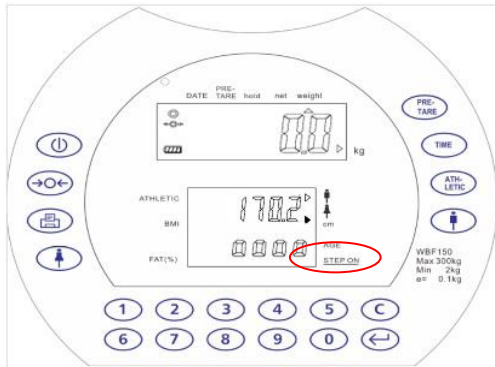

En blinkande pil visas bredvid STEP ON. Stå barfota på vågens alla 4 elektroder, den övre skärmen kommer visa uppmätt vikt. (Fig. 5).

5

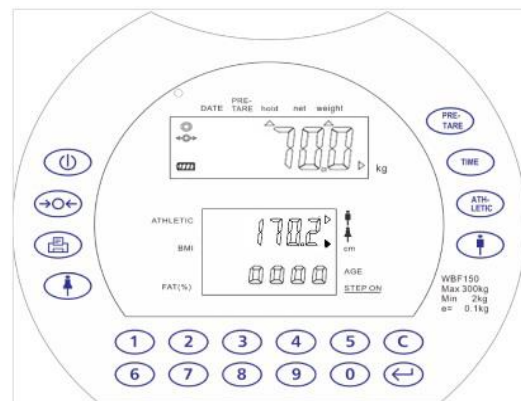

Den under skärmen visar "0000", och börjar analysera kroppen.

6

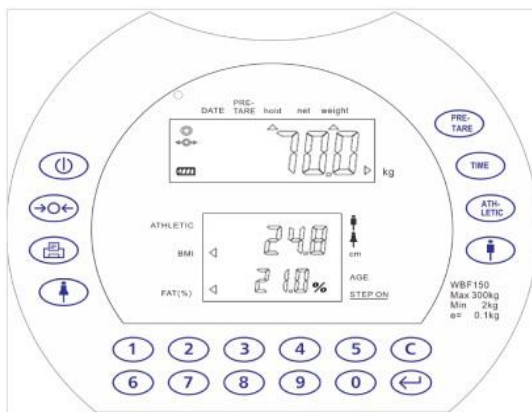

Den under skärmen kommer sedan att visa BMI och % kroppsfett.

7

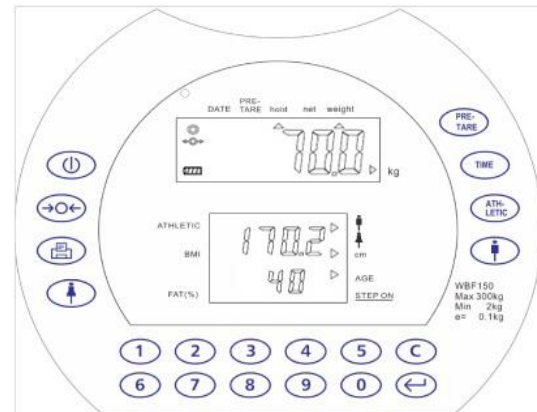

På  kan skärmen växlas till den inmatade åldern och längden

För att skriva ut resultatet, se till att skrivaren är startad.

Tryck på  för att skriva ut resultatet.

8.5 TARE (KLÄDER):

Den här funktionen tillåter att räkna bort vikt från kläder (observer att vägning ska ske barfota)

Starta vågen genom att trycka på  när vågen visar  tryck på . Skärmen kommer nu att visa 0.000

blinkande, välj med nummerpanelen hur mycket som ska dras bort t ex **001,5kg** bekräfta sedan med .

Det inställda värdet kommer nu att visas som negativt värde istället för att vågen börjar på 0 kg. Värdet kommer vara kvar tills det är ändrat eller borttaget.

För att ta bort värdet, gör om detta steg men ändra alla siffror till 000,0 kg, bekräfta sedan med .

9. PRINT FUNCTION

Standard	EIA RS-232 Compatible
Method of communication	Transmission asynchrony
Speed	9600 bps
Data length	8 bits
Parity Check	None
Stop bit	1 bit
Handshake	None
Code	ASCII

Linea serial RS232

Terminal	Signal
2	TX
3	RX
5	GND

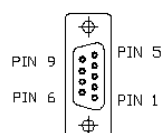

Om en anslutning till PC eller skrivare TP2100, använd använd serial cable invert (pin 2 e 3).



UTSKRIFTSRESULTAT

WUNDER	
15/ 03 / 2013 10: 30	
Vikt	70,5kg
Längd	180,0cm
Tare: klädernas vikt	1,5kg
BMI: Body Mass Index	25,3
FAT: Kroppsfett	25,5%
FAT: Kroppsfett	15,7kg
FMM: Fri kroppsvikt	55,4kg
BMR: Basal Metabolic Rate	1660 ckal
TBW: Total kroppsvatten	41,8kg
Impedans	603Ω

Utskriftsformatet till höger är standard och kan inte ändras.

För mer information: info@wunder.it eller service@wunder.it

Start Menu → Programs → Accessories → Communication → Hyper Terminal.

- [New Connection Description](#)

Give new connection a name then click OK.

- [Select Your COM Port](#)

Click Connect to select your COM port. Usually there's only one option for select. Then click OK.

- [Port Settings](#)

Click Bits per second to set up rate at 9600, Data bits at 8, Parity at None, Stop bits at 1 and Flow control at Hardware. Then click OK to complete your setting.

- [Output Data](#)

When press the PRINT key to output data from scale to PC or an Optional Printer.

10. MAINTENANCE AND ASSISTANCE

For better and longer duration of the product it should receive thorough general cleaning periodically.

The instrument must be cleaned with a soft cloth moistened with water or neutral detergent, without using solvents or abrasive substances. If the instrument remains idle for a long period, remove the batteries from the terminal.

During shipping, make sure not to subject the instrument to blows or excessive mechanical stress.

In case of repairs or assistance, contact your dealer or an authorized service centre contacting service2@wunder.it or sales@wunder.it.

11. CONFORMITY

WUNDER MODEL WBA CABLE ELECTRONIC BODT FAT COMPOSITION SCALE SERIAL N°

We hereby certify that this instrument has been inspected and has successfully passed the functional test.
It complies with the following standards and directives:

**EN 45501 / EN60601-1-2 / EN60601-1
93/42/EEC – Medical Devices Directive**

12. SCRAPPING AND WASTE DISPOSAL

If set aside for a long period, protect those parts which could be damaged due to dust build-up

Scrapping

When you decide to no longer use this item, we recommend making it unusable. We also recommend making those parts which could be sources of danger harmless

Waste disposal  EU 2002/96/EC

This product complies with the EU Directive 2002/96/EC. The symbol of the crossed-out waste bin on the appliance indicates that the product, needing to be treated separately

from household waste, at the end of its useful life must be completed in a separate collection facility for electric and electronic appliances or returned to the dealer upon purchase of a new equivalent appliance. The user is responsible for bringing the appliance to an appropriate collection structure at the end of its life. Appropriate separate collection and sending the appliance for recycling, treatment and environmentally compatible waste disposal contributes to avoid possible negative effects on the environment and health and favours the recycling of the materials the product is made of.

For more detailed information regarding available collection systems, contact your local waste disposal service or the shop where the product was purchased.

As consumers, you are obliged by law to return used or dead batteries. You may deposit old batteries at public collection spots in your town or else with any battery dealer who has placed specific collectors for this purpose. Even when scrapping electric and electronic appliances, they must be removed and deposited in specific collectors.

NOTE: The following symbols indicate the presence of harmful substances

Pb Pb = batteries containing Lead

Cd Cd = batteries containing Cadmium

Hg Hg = Batteries containing Mercury



ATTENTION!

Do not throw electric parts and used batteries away with household waste. Dispose of the batteries by means of your closest collection centres.

13. WARRANTY

This certificate must be kept until the warranty has expired.

It must be presented together with the invoice, tax receipt or delivery note providing the name of the dealer and date of purchase whenever a technical intervention is required. Otherwise the user will lose any warranty rights.

The warranty takes effect from the date of purchase and is valid during the entire period foreseen by the current catalogue/pricelist.

By warranty we mean the replacement or repair free of charge of parts making up the appliance which, at the discretion of the manufacturer, are deemed faulty from the origin; Wunder therefore has the faculty of repairing or replacing the item.

The warranty does not cover:

- shipping faults, damage caused by falls, carelessness or tampering
- damage caused by incapability of using the appliance and of its improper use
- damage caused by an insufficient or inadequate electrical system or alterations resulting from environmental, climatic or other types of conditions
- damage due to incorrect installation of the appliance and repairs carried out by unauthorized personnel
- Interventions at home for convenience controls or presumed defects
- Routine maintenance and that which can be considered normal wear from use
- consumables such as: power supplies, batteries, keyboards, plates, wheels, heads, rolls, load cells faulty due to blows or overloads

Service can also be refused when the appliance has been changed or transformed in any way.

In case of interventions at one's home, the customer must pay the fixed fee; if however the appliance is repaired at an authorized Wunder Service Centre, expenses and relative travel risk are borne by the user.

Wunder will not be held liable for damage of any nature caused directly or indirectly to persons, animals or objects resulting from failure to comply with all the instructions indicated in this manual or anyway resulting from improper use.

The Court of Bergamo has jurisdiction in case of any dispute

14. THERMAL PRINTER (TILLVAL)



 Read this manual carefully before using the instrument

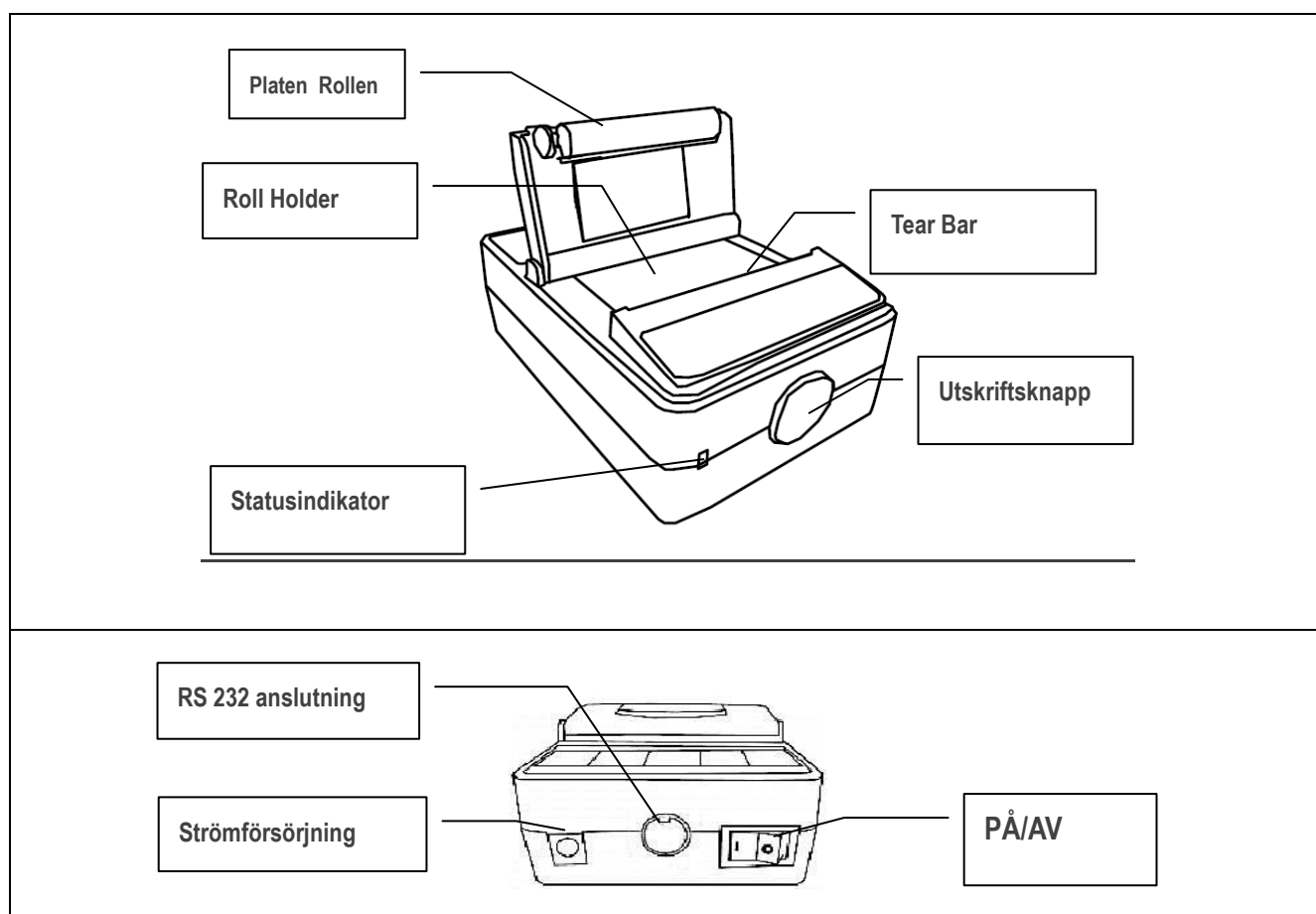

14.1. HUR DU ANVÄNDER SKRIVAREN HOW TO USE YOUR PRINTER

Connect the AC Adaptor and RS232 interface cable. Press the I/O button to power on the printer.

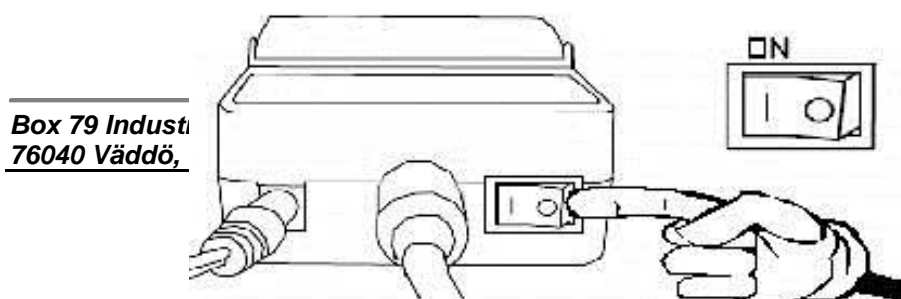

**Box 79 Industri
76040 Vaddö,**

**www.vetek.se
info@vetek.se**

The PRINTER XL printer can be connected via the RS232 port and cable with the RA200 XL.

Press the PRINT key.

Print double language

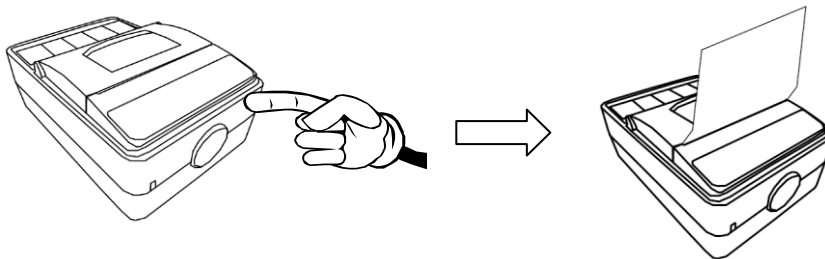

CHANGING THE PAPER ROLL

The paper print roll on a PRINTER XL printer is changed as follows:

1. Open the upper cover and position the paper roll so that it feeds in the right direction.

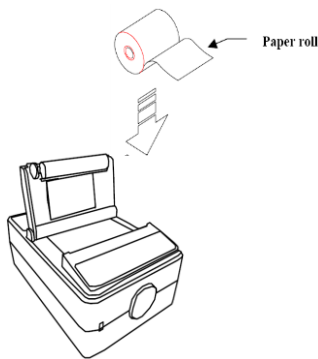

2. Feed the end of the paper roll through the printer cover and close the cover. The printer is ready to print.

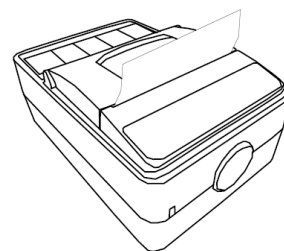

14.2. PRINTER SPECIFICATION

ITEM	SPECIFICATION
Printing method	Thermal dot line printing
Number of dots	384 dot/line

Resolution (dots/mm)	8 dot/mm
Printing width (mm)	48 mm
Max. paper thickness (µm)	80µm
Paper	57.5±0.5 mm (W) x ψ30mm max
Paper loading	Easy loading
Printing speed (mm/s)	75 mm/s
Dimensions (L x W x H)	120 x 80 x 50mm
Operating temperature (°C)	0° to 50°C
Operating humidity (%)	20% to 85% (no condensation)
Interface	Conform to RS232
Voltage range (adaptor only)	12V 2A

SHOCK HAZARD WARNING

The printer and power supply should never be operated in a location where either one can get wet. Personal injury could result.

MEDIA WARNING

Always use high quality approved paper print roll. The approved product can be ordered from your dealer.

RELOADING HINT

If printer runs out of paper roll while printing, switch the power off and reload paper roll. Power on and print again.

14.3. ERROR MESSAGES

Problem	Solution or Reason
Status Indicator does not light when power switch is turned to ON (I) position.	Check the power connections from AC outlet to the printer power supply.
Status indicator illuminated (green light), but the printer will not print.	Check interface cable connections from the scale to printer. Make sure the top cover is closed and locked.
Printer paper jammed.	Reset the paper roll. Please refer to "CHANGING THE PAPER ROLL".
Status Indicator is flashing green.	Paper roll is out. Reload a new source of paper roll so the printer can continue printing. Please refer to "CHANGING THE PAPER ROLL".











15. ASSEMBLY-USE MECHANICAL TELESCOPIC HEIGHT METER (OPTIONAL)



ATTENTION!

ONLY FOR COLUMN SCALE

HEIGHT ROD KIT

1.Metal support for telescopic height meter			 side view metal support		
2. Black abs support height meter					
3.Screws	 A) N°02 screws T.E. (M5x16)	 B) N°02 slotted screws (M5x25)	 C) N°01 Allen Screws (M6x12)	 D) N°02 nuts \varnothing 5	 E) N° 02 washers \varnothing 5
4.Tools	 Tools		 Allen tools		

Picture 1: Assemble white metal support with abs black part white the screws (B+E). Lock all with the screws (D)

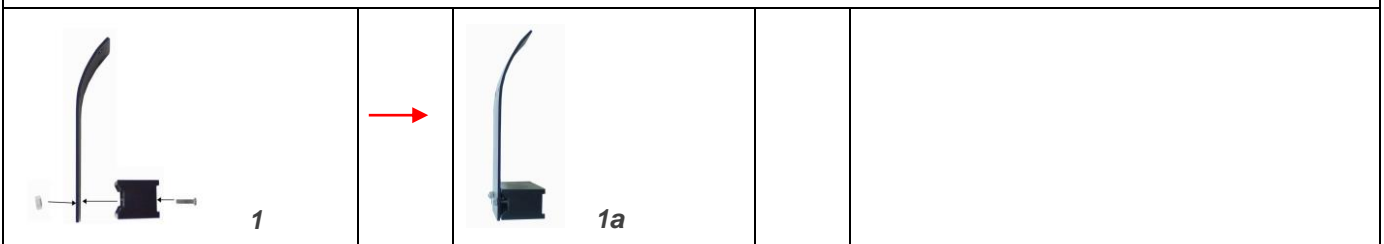

Picture 2-2a: behind the pole (column) assemble the white metal support with screws (B). **Picture 2b:** the position is on the right

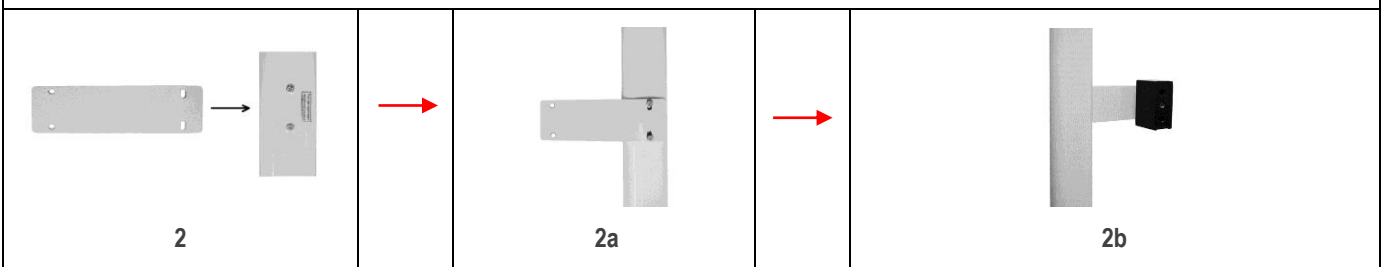

Picture 3-3a: assemble the height rod on black abs support with screws (C) and allen tools kit **Picture 3b:** The height rod is ready for use.

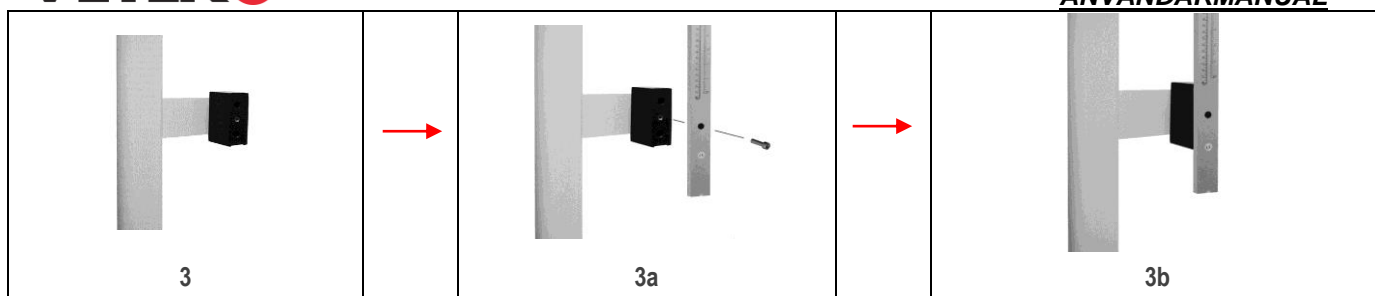

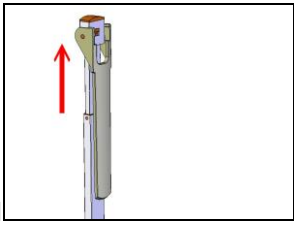
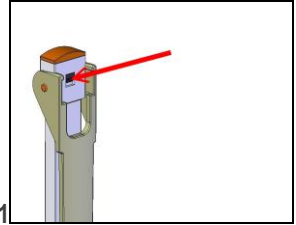
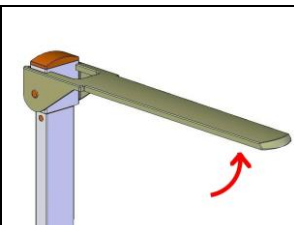
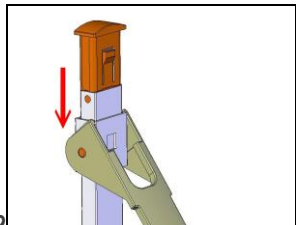
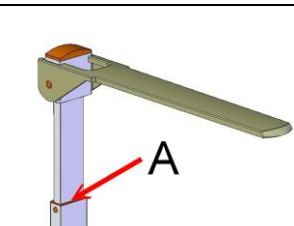
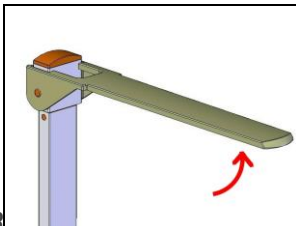
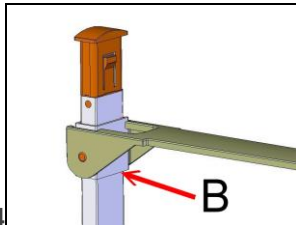
MEASURING OVER 131 cm		MEASURING UNDER 130 cm	
1 	Pull up the height meter rod	1 	Press the black button and measuring height and push down
2 	Position it horizontally	2 	
3 	Lower the rod up to the point where the lever rests head touches the patient's head. The height can be read at the point 'A'	3 	Position it horizontally
		4 	Lower the rod up to the point in which the blade rests head touches the patient's head. The height can be read at point 'B'.